

Peak Sensitivity Wavelength: 940nm

The MTD3910GC-F3 is a high speed and high sensitive PIN photodiode in a standard 5mm plastic package. Due to filtering material the device is designed to reduce visible light sensitivity.

FEATURES

- > Fast Response Time
- > High Photo Sensitivity
- > Small Junction Capacitance
- > Pb Free / RoHS Compliant

APPLICATIONS

- > High Speed photodetector
- > Security System
- > Camera

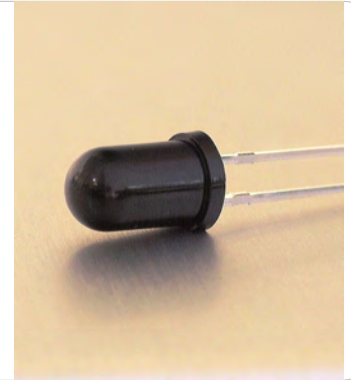

Absolute Maximum Ratings (Ta=25°C)



ITEMS	SYMBOL	RATINGS	UNIT
Reverse Voltage	VR	20	V
Power Dissipation	PD	50	mW
Operating Temperature Range	Topr	-20 ~ +85	°C
Storage Temperature Range	Tstg	-30 ~ +100	°C
Lead Soldering Temperature*1	Tls	260	°C

*1: Time 5 Sec max, Position: Up to 3mm from the body.

Electrical & Optical Characteristics (Ta = 25°C)

ITEMS	SYMBOL	CONDITIONS	MIN	TYP	MAX	UNIT
Light Current	IL	IL=1000Lux, VR=10V	35	45	--	μA
Dark Current	ID	VR=10V	--	--	10	nA
Junction Capacitance	Cj	f=1MHz, VR=2.5V	--	6	12	pF
Spectral Sensitivity	λ	--	850	--	1060	nm
Peak Sensitivity Wavelength	λp	--	--	940	--	nm
Responsivity	R	λ= 970nm	--	0.44	--	A/W
Quantum Efficiency	QE	λ= 970nm	--	58	--	%

Package Dimensions

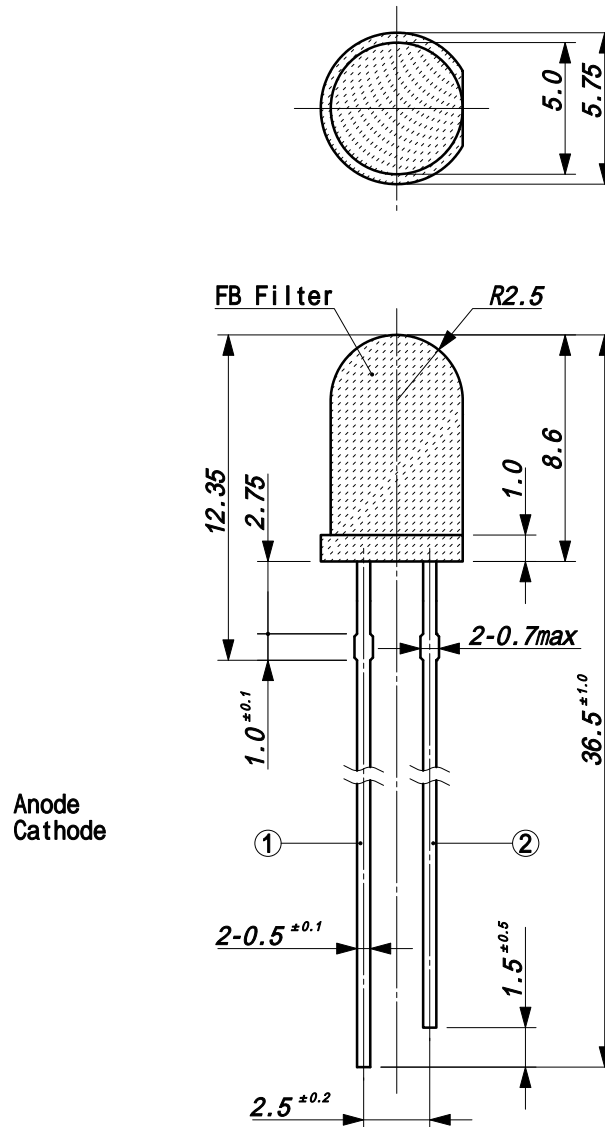

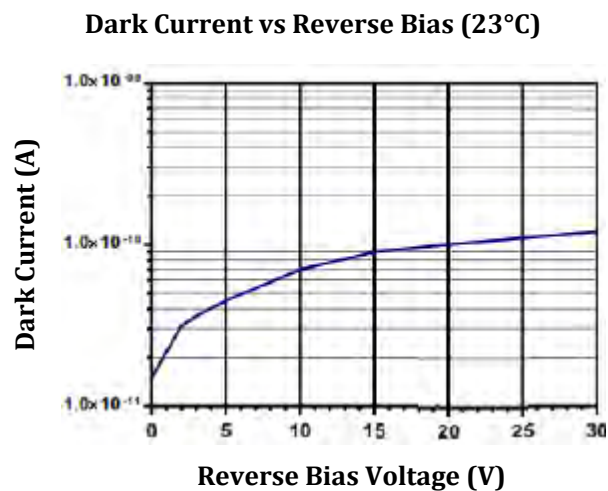
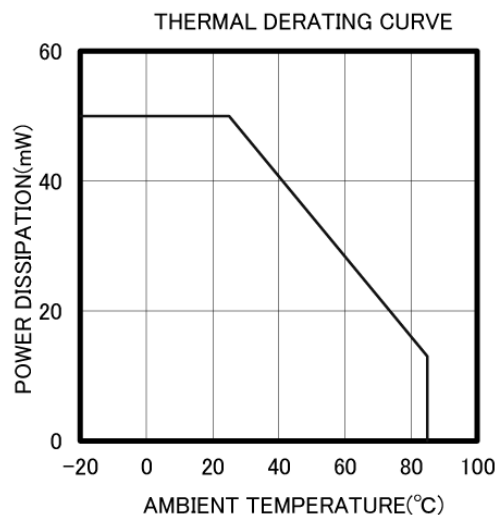
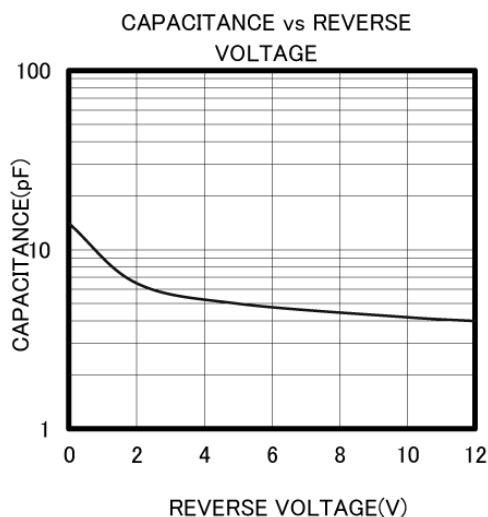

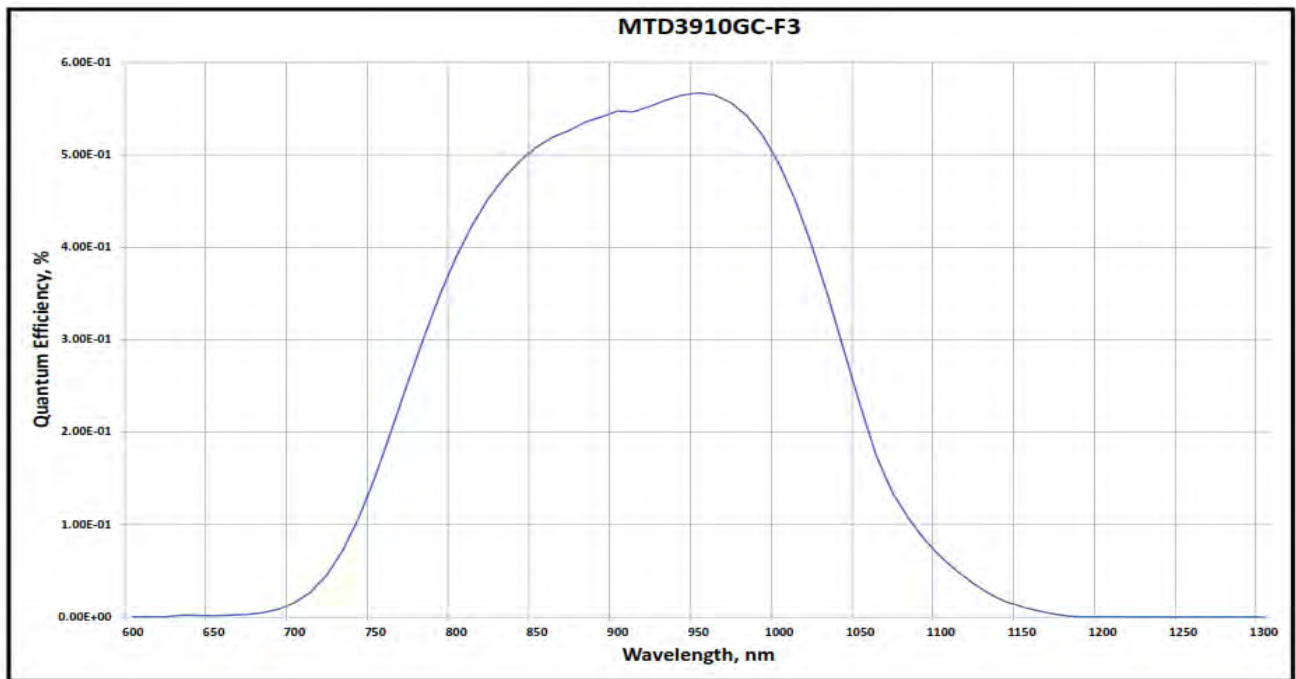
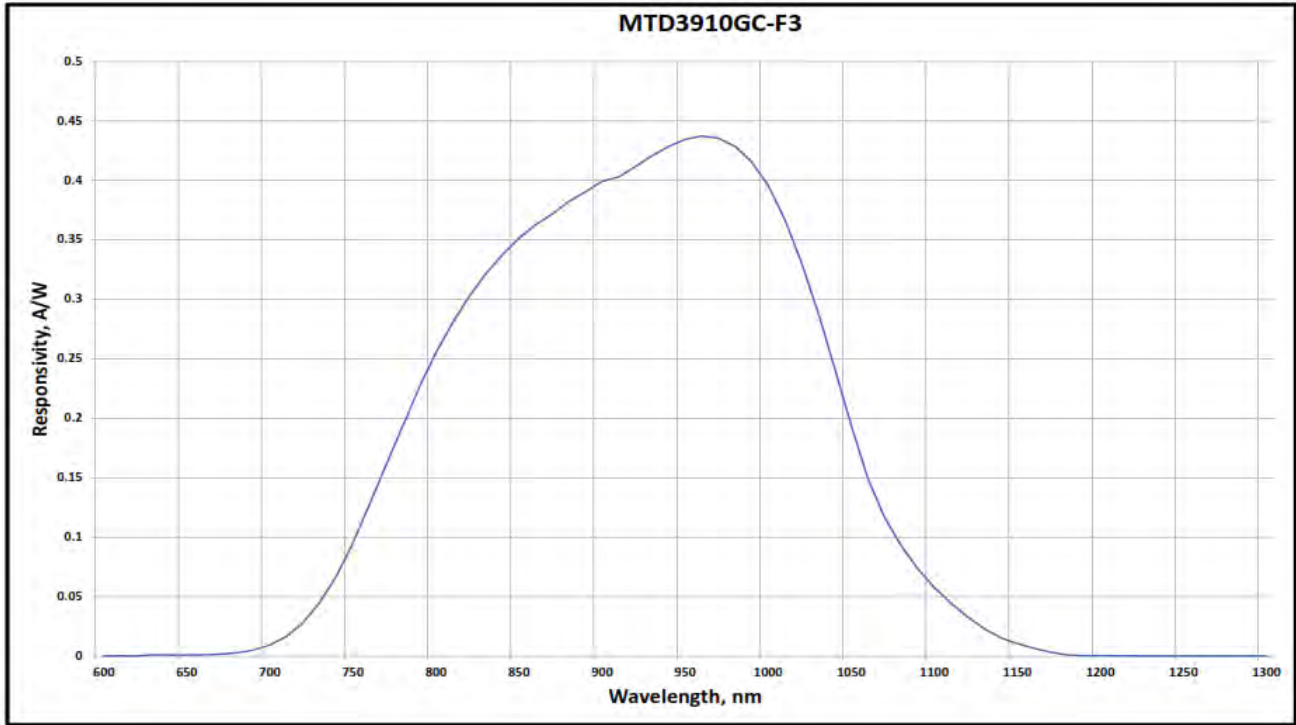

The information contained herein is subject to change without notice.

2024-04-04